

YASKAWA

Low Harmonic Regenerative Pump Controller U1000 iQpump Drive Quick Start Procedure

Type: CIMR-UW

Models: 200 V Class: 10 to 100 HP ND
400 V Class: 7.5 to 800 HP ND

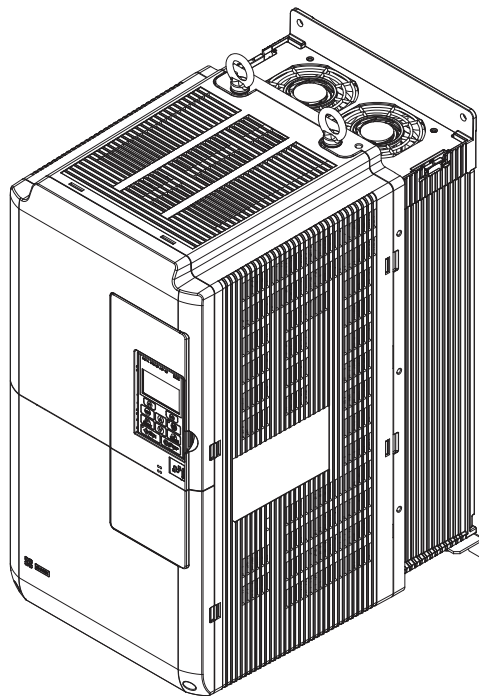

MANUAL NO. TOEPYAIUPW02B
PUBLISHED FEBRUARY 2018
Revision: <1>
DRIVE SOFTWARE PRG: 0030

Contents

STEP 1:	<input type="checkbox"/> IDENTIFY THE MODEL FOR INSTALLATION.....	3
STEP 2:	<input type="checkbox"/> PERFORM MECHANICAL INSTALLATION.....	4
STEP 3:	<input type="checkbox"/> MOTOR LINE POWER	5
STEP 4:	<input type="checkbox"/> SELECT START/STOP AND SPEED METHOD.....	6
STEP 5:	<input type="checkbox"/> REAL-TIME CLOCK SETUP	9
STEP 6:	<input type="checkbox"/> APPLICATION SETUP.....	10
STEP 7:	<input type="checkbox"/> PARAMETER OVERVIEW-QUICK SETTING MENU (SIMPLEX).....	12
STEP 8:	<input type="checkbox"/> FINE-TUNE SETTINGS FOR PUMPING APPLICATION	14
STEP 9:	<input type="checkbox"/> VERIFY PUMP ROTATION AND TRANSDUCER FEEDBACK	16
STEP 10:	<input type="checkbox"/> AUTO MODE OPERATION	17
STEP 11:	<input type="checkbox"/> HAND MODE OPERATION.....	20
STEP 12:	<input type="checkbox"/> PROGRAMMING ADVANCED PARAMETERS	21
STEP 13:	<input type="checkbox"/> SLEEP AND ANTI-NO-FLOW (ANF) DETECTION	23

**STEP
1**

Identify the Model for Installation

Safety Symbols in this Document

WARNING!
Read and understand users manual before using this equipment. Failure to follow users instructions may result in serious injury or death.

WARNING!
Hazardous Voltage. Contact may cause electric shock or burn. Turn-off and lock-out system and facility power before servicing.

WARNING!
Stay Clear- Equipment starts automatically. Clear all personnel from equipment, install shields or guards, locate and verify emergency SHUT-OFF is functional. Failure to comply may result in serious injury to personnel.

WARNING!
Improper Operation Sequence. DO NOT RUN THE MOTOR. Failure to comply may result in serious injury to personnel.

WARNING!
Do not operate equipment with covers or guards removed. Install or replace cover and/or guards before operation. Failure to comply may result in serious injury to personnel.

This Quick Start Procedure serves as general guide to help install, configure and perform test run operation. Refer to the U1000 iQpump Drive User Manual No. TOEPYAIUPW01 for complete instructions to configure this product for each specific installation site.

Terminology

U1000 iQpump Drive is referred to as “drive” throughout this document.

1.1 Verify the correct model and ratings.

Follow this procedure for each drive and motor combination.

- a. Locate the nameplate and your order information.
- b. Verify the Model Number matches the line item(s) on your order, to confirm receipt of the correct model.
- c. Locate the nameplate of motor that will be connected.
- d. Confirm the motor nameplate Amperage, Voltage, and Frequency (Hz) are within the Output specifications shown on the drive nameplate.

1.2 Verify main power source is adequate by reviewing the Input specifications shown on the drive nameplate.

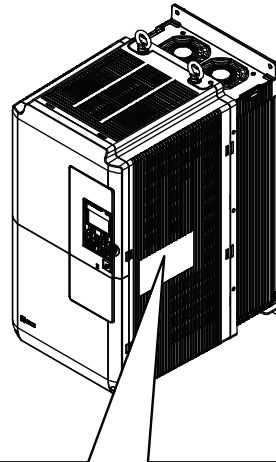

Drive Model Number	MODEL : CIMR-UW2A0028AUA REV : A	Drive Spec Number	
Input Power Rating	C / C : CIMR-UW2A0028AUA	UL LISTED	
Output Power Rating	INPUT : AC3PH 200-240V 50/60Hz 25A	IND.CONT.EQ. 7J48	Normal Duty Amps
Weight	OUTPUT : AC3PH 0-240V 0-400Hz 28A	PRG : 0000	Software Version
Serial Number	MASS : 21 kg	O / N : 6W3050-2-100	
UL File Number	S / N : J0073D207410100	FILE NO : E131457	
		IP00	
		PASS	
		RoHS	
	YASKAWA ELECTRIC CORPORATION	Assembled in U.S.A.	
	2-1 Kurosaki-shiroishi, Yahatanishi-Ku	Kitakyushu 806-0004 Japan	
	Enclosure Type		

STEP 2 **Perform Mechanical Installation**

2.1 Verify installation environment.

Mechanical installation and mounting footprint vary by model. Refer to the U1000 iQpump Drive User Manual No. TOEPYAIUPW01, Chapter 2: Mechanical Installation for details. Ensure the installation conditions are suitable to prolong and optimize performance life.

Environment	Conditions
Installation Area	Indoors
Ambient Temperature	IP00/Open Type enclosure: -10 °C to +50 °C (14 °F to 122 °F) IP20/NEMA 1, UL Type 1 enclosure: -10 °C to +40 °C (14 °F to 104 °F) <1> Drive reliability improves in environments without wide temperature fluctuations. When using the drive in an enclosure panel, install a cooling fan or air conditioner in the area to ensure that the air temperature inside the enclosure does not exceed the specified levels. Do not allow ice to develop on the drive.
Humidity	95% RH or less and free of condensation
Storage Temperature	-20 °C to +60 °C (-4 °F to +104 °F)
Surrounding Area	Install the drive in an area free from: <ul style="list-style-type: none"> oil mist and dust metal shavings, oil, water, or other foreign materials radioactive materials combustible materials (e.g., wood) harmful gases and liquids excessive vibration chlorides direct sunlight.
Altitude	1000 m (3281 ft.) or lower, up to 3000 m (9843 ft.) with derating
Vibration	20 to 55 Hz: 5.9 m/s ² (2□0104 to 2□0248, 4□0096 to 4□0930: 2.0 m/s ²) 10 to 20 Hz: 9.8 m/s ² (4□0477 and 4□0930: 5.9 m/s ²)
Orientation	Install the unit vertically to maintain maximum cooling effects.

<1> Attach a top protective cover and bottom cover from the optional End Cap Kit to an IP00/Open Type enclosure drive to convert the drive to an IP20/NEMA 1, UL Type 1 enclosure drive.

2.2 Maintain installation clearances.

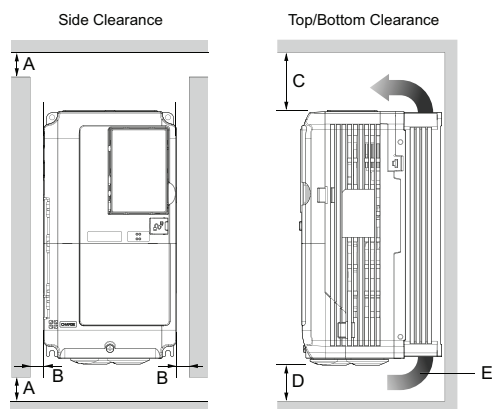

Ensure the back panel is placed against a closed flat surface for proper cooling.

NOTICE: Abnormal Operation. Avoid placing peripheral devices, transformers, or other electronics near the drive as the noise created can lead to abnormal operation. Take proper steps to shield the drive from electrical interference if such devices must be used in close proximity to the drive.

NOTICE: Equipment Damage. Prevent foreign matter such as metal shavings and wire clippings from falling into the drive during installation. Failure to comply could result in damage to the drive. Place a temporary cover over the top of the drive during installation. Remove the temporary cover before drive start-up, as the cover will reduce ventilation and cause the drive to overheat.

Install Type	Minimum Spacing				E
	A	B	C	D	
50 mm (1.97 in)	30 mm (1.18 in)	200 mm (7.87 in)	120 mm (4.72 in)	Airflow direction	

STEP
3

□ Motor Line Power

3.1 ⚠️🔍 **Remove the front cover.**

NOTICE: Improper removal of the drive's protective covers can cause damage to the drive. Adhere to U1000 iQpump Drive User Manual TOEPYAIUPW01, Section 3.5, to avoid drive damage.

3.2 ⚠️ **Connect main input power and motor wiring to the drive.**

Refer to Figure 3.1 for three-phase input power drive models.

Follow accepted wiring practices and applicable electric codes. Ensure all equipment is properly grounded.

WARNING! Fire Hazard. Do not connect terminals p1 or n1 terminals to earth ground. Only connect ground wiring to designated ground terminals. Improper wiring connections could result in death or serious injury by fire.

Figure 3.1 Motor and Power Line Connections

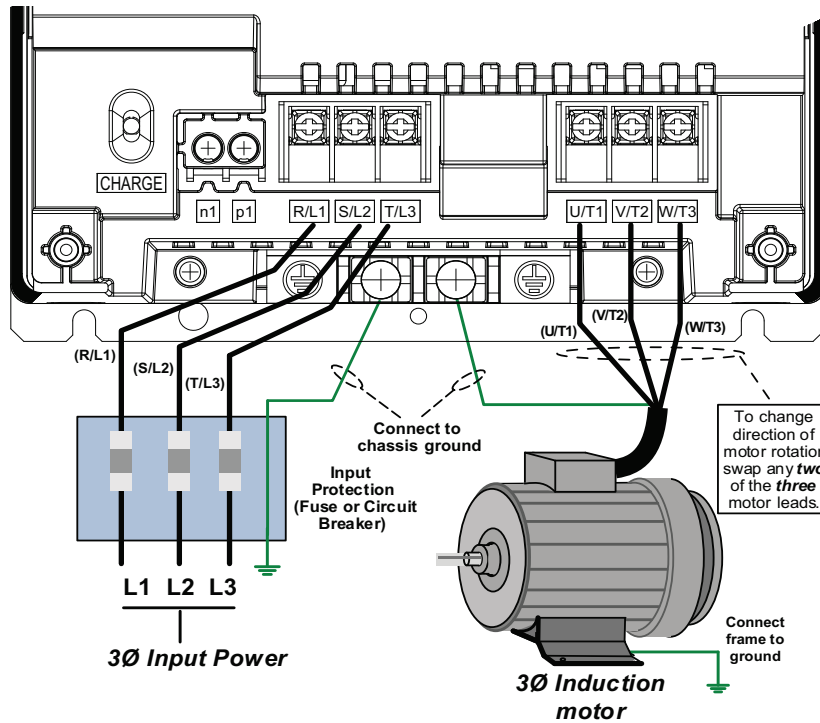

STEP 4 **Select Start/Stop and Speed Method**

4.1 ⚠ De-energize the drive before removing terminal covers.

4.2 Remove drive terminal covers.

Figure 4.1 Terminal Cover Removal

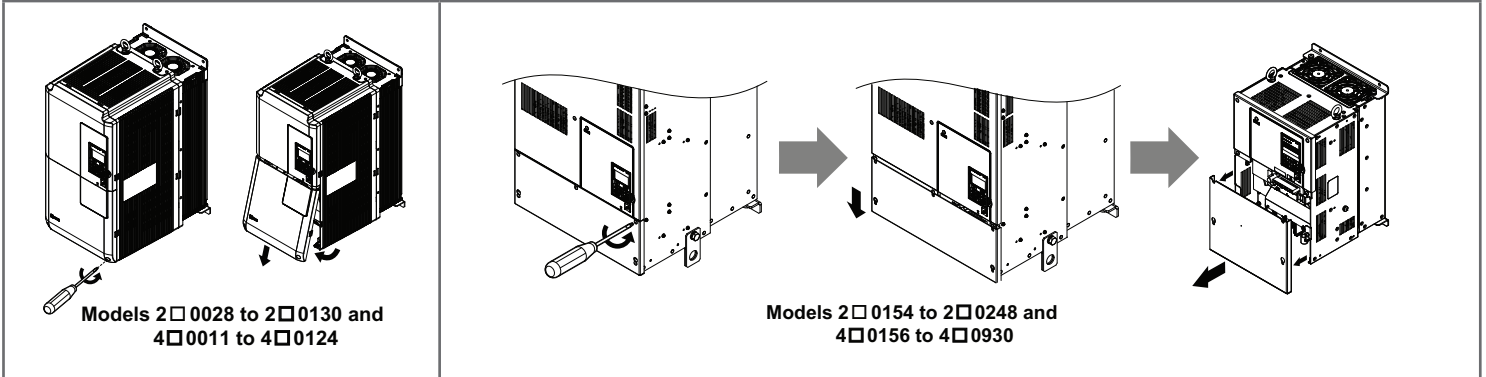

4.3 Select Start/Stop Control Method

START/STOP from the HOA keypad is the default start/stop method. If this is the preferred start/stop method, proceed to Step 4.5, Feedback Signal Wiring.

If START/STOP will be controlled by a maintained contact from an external switch at the drive I/O terminals, then set parameter b1-02 Run Command Selection to 1 (Digital Inputs). Refer to Step 4.6 for an example of setting a parameter.

Refer to Figure 4.2 to start/stop the drive using an external switch or contact on drive terminals.

4.4 Start/Stop control method using an external switch or contact.

Figure 4.2 2-Wire Control - Use for Maintained Contacts

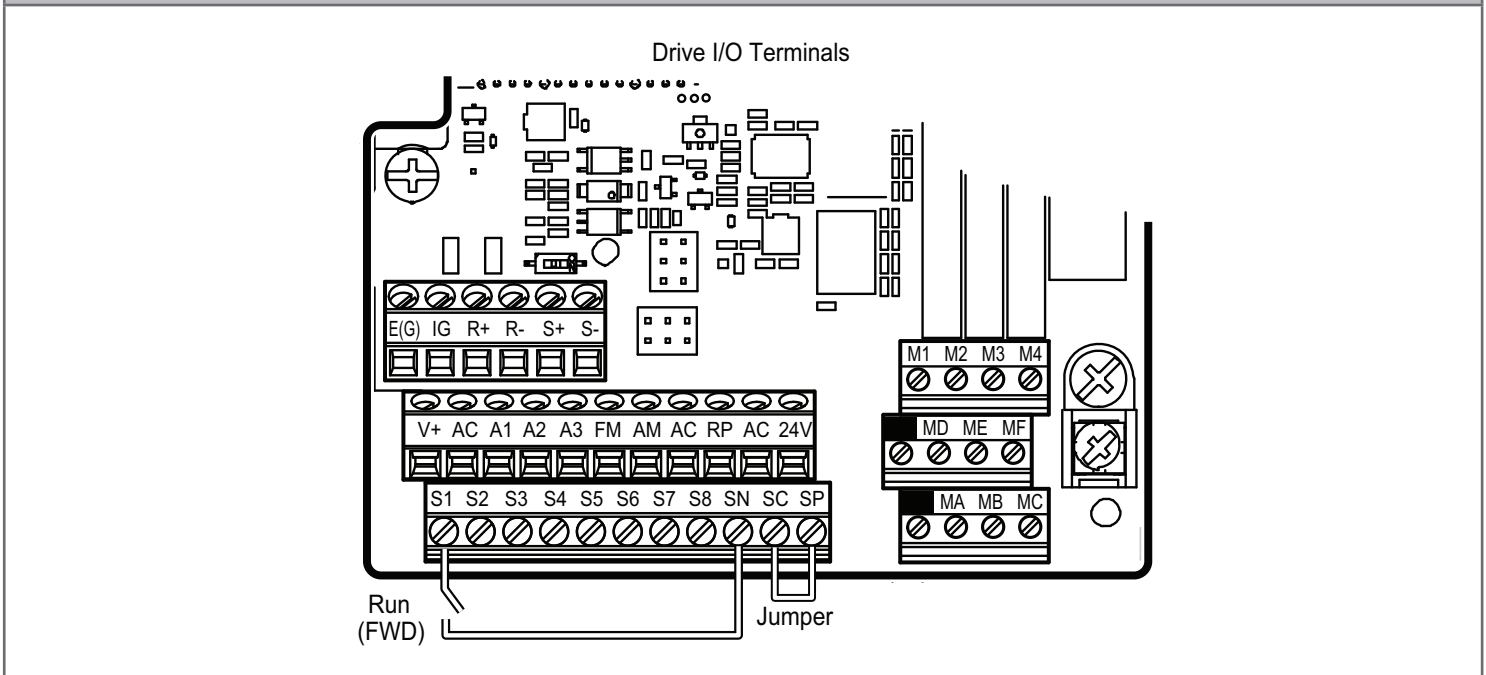

STEP 4

Select Start/Stop and Speed Method (continued)

4.5 Feedback Signal Wiring (Transducer)

To connect a 4-20 mA 2-wire transducer, follow Figure 4.3
OR
To connect a 0-10 V 3-wire transducer follow Figure 4.4

Figure 4.3 (2-Wire) 4 to 20 mA Transducer

Jumper S1 Signal Type Selection

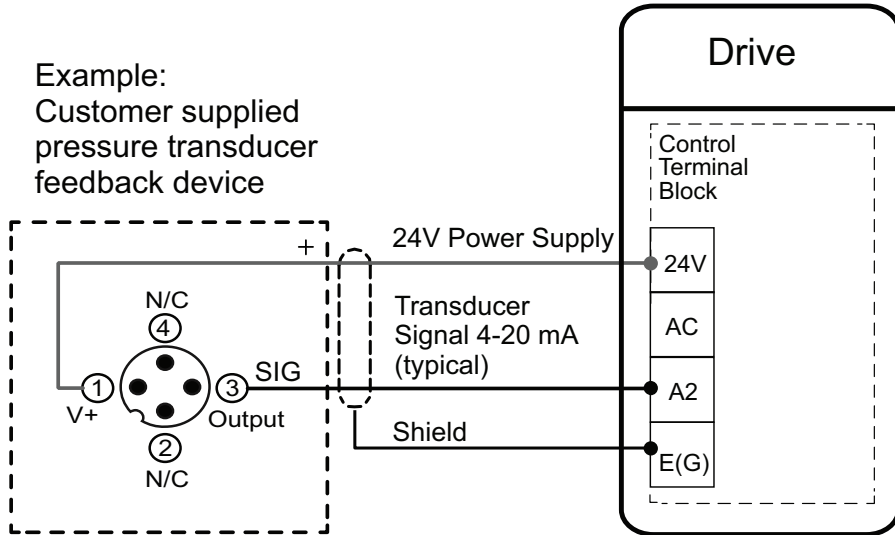

Setting	Description
V (top position)	Voltage input (-10 to +10 V or 0 to 10 V)
I (bottom position)	Current input (4 to 20 mA or 0 to 20 mA)

Add a jumper between terminals AC and SN if not already installed from the factory.

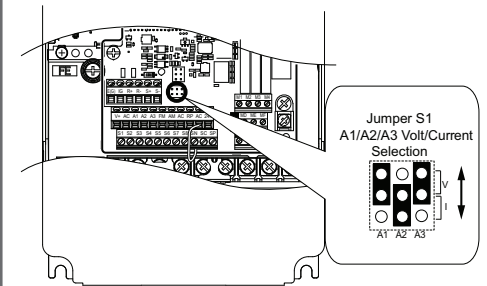
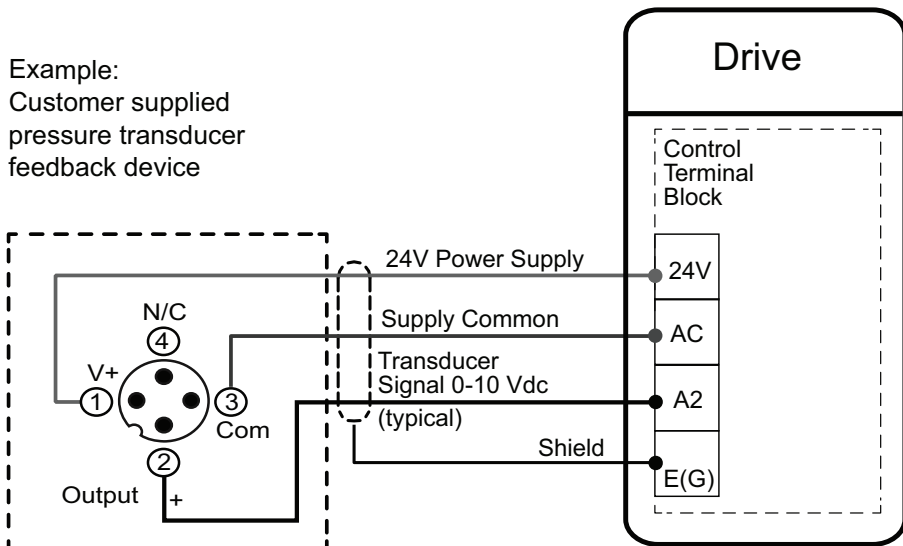

Figure 4.4 (3-Wire) 0 to 10 V Transducer

Parameter H3-09 Details



No.	Parameter Name
H3-09	Frequency reference (current) terminal A2 signal level selection
Description	
Selects the signal level for terminal A2.	
0: 0 to +10 V, (unipolar input with lower limit)	
1: 0 to + 10 V, bipolar input (no lower limit)	
2: 4 to 20 mA (Default Setting)	
3: 0 to 20 mA	

See Step 4.6 for an example of setting parameters.

Note: Refer to Section B.7, Option Settings, in the U1000 iQpump Drive User Manual (No. TOEPYAIUPW01) to program the drive for network communication if required.

STEP 4 **Select Start/Stop and Speed Method (continued)**

4.6 Example of Setting Parameters

 **DO NOT RUN THE MOTOR.** Ensure all protective covers are installed and power is turned on.

Refer to Parameter C1-02 Setting Example below for information on how to access and set parameters.

Parameter C1-02 Setting Example

Press **F1** key to display the main menu.

```

- MODE -   DRV Rdy
  Auto Setpoint
U5-99=  0.0PSI
U1-02=  0.00Hz  LSEQ
U1-91=  0.0PSI  LREF
  <- MONITOR ->
    
```

```

- MODE -   PRG
  Programming
  [Pencil icon]
HOME  FWD
    
```

```

- PRMSET-  PRG
  Select language
P1--00  0
  Select Language
HOME  FWD  ->
    
```

3X 







 Select Digit

```

- PRMSET-  PRG
  Basic Setup
P1--00  0
  Select Language
HOME  FWD  ->
    
```

Increase/Decrease Selection



Press twice to go to the next digit.



```

- PRMSET-  PRG
  Accel Time 1
C1-01=  20.0sec
(0.0~6000.0)
'20.0sec'
HOME  FWD  ->
    
```

Increase/Decrease Selection

```

- PRMSET-  PRG
  Decel Time 1
C1-02=  10.0sec
(0.0~6000.0)
'10.0sec'
HOME  FWD  ->
    
```

Press  to switch to edit mode.

```

- PRMSET-  PRG
  Decel Time 1
C1-02=  0010.0sec
(0.0~6000.0)
'10.0sec'
HOME  FWD  ->
    
```

Modify Value

```

- PRMSET-  PRG
  Decel Time 1
C1-02=  0020.0sec
(0.0~6000.0)
'10.0sec'
HOME  FWD  ->
    
```

Press  to save new value.

Press **F1** to return to the main menu.

STEP 5 Real-time Clock Setup

5.1 Power up the drive and set the Real-time Clock.

The Real-time Clock setup screen will appear at first power up. Press **F2** to set the clock.

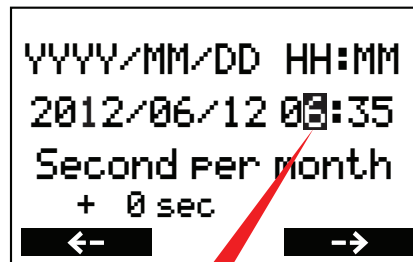
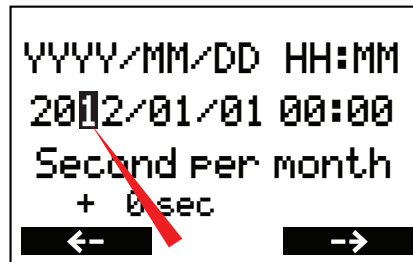
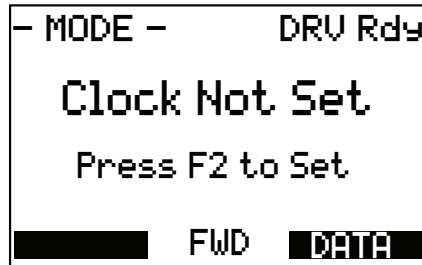

Press **F1** to move the cursor to the left and **F2** to move cursor to the right. Press **▲** **▼** to adjust.
Press **ENTER** to save after setting time.

Note: DO NOT adjust Second per month.

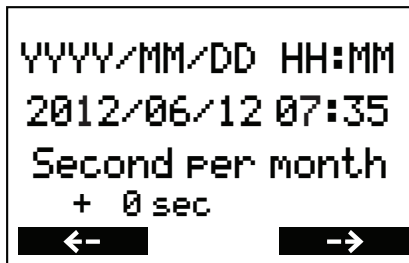

Example: June 12th 2012, 7:35 am

Note: After the real-time clock is set, the real-time clock setup screen will not display again unless parameter o4-17 is set to 1.



STEP 6 □ Application Setup

6.1  **Configure the drive for a dedicated pump application.**
DO NOT RUN THE MOTOR. Ensure all protective covers are installed and power is turned on.

Select one of the Application Macro settings shown below from Initialization parameter A1-03. Refer to Step 6.2 for an example of setting a parameter using the keypad.

- 0: No Initialization (**Factory Default**)
- 1110: User Initialize (parameter values will be stored using parameter o2-03)
- 2220: 2-Wire Initialize
- 3330: 3-Wire Initialize
- 5550: Terminal->Control Initialize
- 6008 Pressure Control (PSI)
- 6009 Pump Down Level Mode (Ft)
- 6011 VTC Pressure Control Mode
- 6012 VTC Pivot Panel Mode
- 6013 Advanced Pressure Control Mode
- 6014 Pivot Panel Submersible Mode
- 7770 General Purpose
- 7771 General Purpose Submersible Motor Mode

6.2 Application Macro setting example using parameter A1-03.

Keypad Example: Setting Parameter A1-03

Press **F1** key to display the main menu, then press .

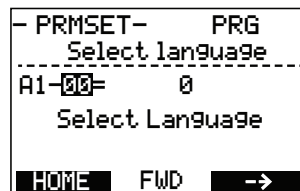
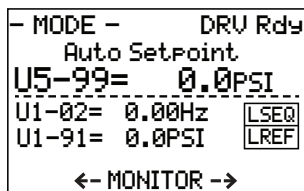

2X  →  → 2X  Select Digit

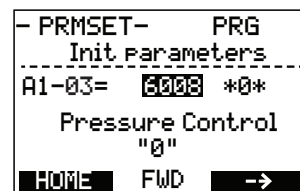

Increase/Decrease Selection



Switch to Edit Mode



Select Application

Press  to select

STEP 6 □ Application Setup (continued)

6.3  Configure the drive for a dedicated pump application.

Enter Application Parameters

Press the **F1** key to return to the main menu.

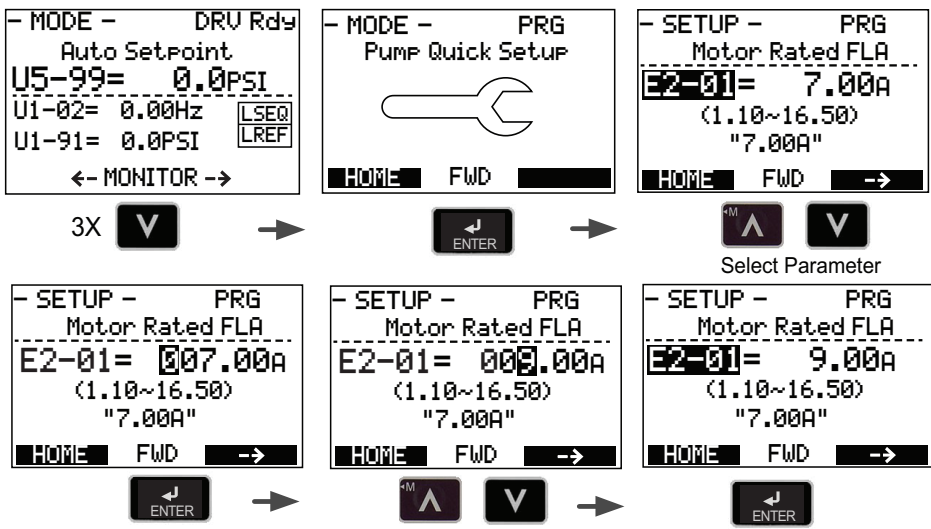

3X **V** → **ENTER** → **^** **V**
Select Parameter

ENTER → **^** **V** → **ENTER**
Switch to Edit Mode Modify Value Save New Value

6.4 Press **F1** key to return to the main menu.

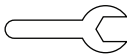
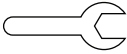
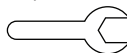
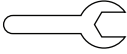
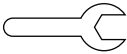
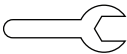

STEP
7

□ Parameter Overview - Quick Setting Menu (Simplex) Pressure Control

Task	Parameter	Name	Description/Menu Access	Default Value
<p>7.1 Read-only parameter. It cannot be modified. Factory set to (0: Pressure control)</p>	A1-06	Application Preset	<p>Displays selected applications, see Step 6.</p> <p>Pump Quick Setup</p> 	<p>Factory set to (0: Pressure control).</p> <p>Dependent on Initialization Mode</p>
<p>7.2 Set to the motor nameplate full load amps.</p> <p>For submersible motors use service factor amps (SFA).</p>	E2-01	Motor Rated Current	<p>Motor nameplate full load amps.</p> <p>Pump Quick Setup</p> 	Drive size dependent
<p>7.3 Enter '4' for an 1800 RPM motor and '2' for a 3600 RPM motor.</p> <p>Confirm number of poles:</p> <ul style="list-style-type: none"> • 2 Pole Motor = 3600 RPM • 4 Pole Motor = 1800 RPM • 6 Pole Motor = 1200 RPM • 8 Pole Motor = 900 RPM 	E2-04	Number of Motor Poles	<p>Sets the number of motor poles.</p> <p>Number of motor poles is used to show the correct motor RPM on the display</p> <p>Pump Quick Setup</p> 	2
<p>7.4 System Scaling: Enter feedback device maximum:</p> <p>Example: Enter 200 for pressure transducer with a maximum of 200 PSI at 20 mA.</p> <p>Confirm feedback device scaling. (Refer to 8.1, System Feedback Unit/Feedback Device Scaling)</p>	P1-03	Feedback Device Scaling	<p>Sets the scaling of feedback device in user-set units.</p> <p>Pump Quick Setup</p> 	145.0
<p>7.5 Set to system pressure</p>	Q1-01	PID Controller Setpoint 1	<p>Sets the PID Setpoint when b1-01 is set to 0.</p> <p>Pump Quick Setup</p> 	0.0
<p>7.6 Choose one of two types of Start Level programming:</p> <ol style="list-style-type: none"> 1. Program the Start Level as an Absolute. <p>OR</p> <ol style="list-style-type: none"> 2. Program the Start Level as a Delta Level from the System Setpoint. 	P1-04	Start/Drawn Down Level	<p>The system starts when the feedback level drops below the start level for the time set in P1-05 (default 1 second). This level also specifies the wake-up level when the drive is in Sleep Mode. When this parameter is set to a negative value, the feedback level must drop that amount below the setpoint. Setting this parameter to 0.0 disables the function. When P1-01, Pump Mode, is set to 3 (MEMOBUS network), this function is active only on the first drive in the network.</p> <p>Pump Quick Setup</p> 	0.0 PSI

STEP
7

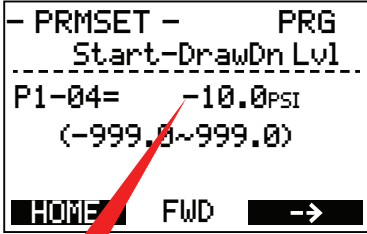
□ Parameter Overview - Quick Setting Menu (Simplex) (continued)

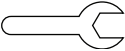
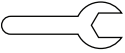
Task	Parameter	Name	Description/Menu Access	Default Value
<p>7.6.1 Program the Start Level as an Absolute Value.</p> <p>Start/Draw Down Level must be programmed to a positive value for the Start/Draw Down Level to be an absolute value.</p> <p>Example: Start/Draw Down Level P1-04 set to 50 PSI and delay time P1-05 set to 5 seconds.</p> <p>Result: Pump system will start when the pressure drops below 50 PSI for 5 seconds.</p>			<p>Important! It is mandatory to program the Start/Draw Down Level in order to use the sleep function. Refer to Step 8, Figure 8.2.</p>  <p>Use  </p> <p>to change the sign. (negative/positive)</p>	
<p style="text-align: center;">OR</p> <p>7.6.2 Program the Start Level as a Delta Level from the System Setpoint.</p> <p>Start/Draw Down Level must be programmed to a negative value for the Start Level to be a delta value from the setpoint.</p> <p>Example: Start/Draw Down Level P1-04 set to -10 PSI with a system setpoint of 50 PSI and delay time P1-05 set to 5 seconds.</p> <p>Result: Pump system will start when the pressure drops below 40 PSI (50 - 10) for 5 seconds.</p>				
<p>7.7 Set Minimum Pump Frequency to the value at which the pump enters a no-flow condition.</p>	P1-06	Minimum Pump Speed	Minimum speed (Hz) for pump motor operation. Pump Quick Setup 	40.0 Hz
<p>7.8 Recommended for use when the Start/Stop command is from the HOA keypad. WARNING! Sudden Movement Hazard. During automatic restart, the machine may start moving suddenly, which could result in death or serious injury.</p>	P4-10	AUTO Mode Operator Run Power Down Storage	Stores the run status in the AUTO mode when operating from HOA keypad (b1-02=0). 0: Disabled 1: Enabled Pump Quick Setup 	0: Disabled
<p>7.9 Optional step: HAND key on HOA keypad.</p>	P5-04	HAND Key Function Selection	Enables or disables the HAND key on the HOA keypad. 0: Disabled 1: Enabled	1: Enabled

STEP 8 Fine-tune Settings for Pumping Application

<p>8.1 System Feedback Unit/ Feedback Device Scaling</p> <p style="text-align: center;">P1-02 Feedback Unit</p> <table style="width:100%; border: none;"> <tr> <td style="width:50%;">0: No Unit</td> <td style="width:50%;">8: °F: DegFahrenheit</td> </tr> <tr> <td>1: PSI: lb.SqrInch</td> <td>9: °C: DegCelsius</td> </tr> <tr> <td>2: Pa: Pascals</td> <td>10: %: Percent</td> </tr> <tr> <td>3: Bar</td> <td>11: kPA: kilopascal</td> </tr> <tr> <td>4: WC: Inch Water</td> <td>25: Flow (Use P6-04)</td> </tr> <tr> <td>5: "Hg: Inch Mercury</td> <td>26: Custom Units</td> </tr> <tr> <td>6: ft: Feet</td> <td></td> </tr> <tr> <td>7: m: meters</td> <td></td> </tr> </table> <p style="text-align: center;">P1-03 200.0 Feedback Scaling</p> <p style="text-align: center;">Feedback Maximum</p>	0: No Unit	8: °F: DegFahrenheit	1: PSI: lb.SqrInch	9: °C: DegCelsius	2: Pa: Pascals	10: %: Percent	3: Bar	11: kPA: kilopascal	4: WC: Inch Water	25: Flow (Use P6-04)	5: "Hg: Inch Mercury	26: Custom Units	6: ft: Feet		7: m: meters		<p>8.2 Start/Draw Down Level - Positive Start</p> <p style="text-align: center;">Example: Absolute Level (Positive Start Level)</p> <p style="text-align: center;">Example: Absolute Level (Negative Start Level)</p> <table style="width:100%; border: none;"> <tr> <td style="width:50%;">System Setpoint (Example 150.0 PSI)</td> <td style="width:50%;">Feedback Scaling (P1-03) (Example 200.0 PSI)</td> </tr> <tr> <td>System Units (P1-02) (Example PSI P1-02=1)</td> <td>Start/Draw Down Level (P1-04) (Example 100.0 PSI)</td> </tr> </table>	System Setpoint (Example 150.0 PSI)	Feedback Scaling (P1-03) (Example 200.0 PSI)	System Units (P1-02) (Example PSI P1-02=1)	Start/Draw Down Level (P1-04) (Example 100.0 PSI)	<p>8.3 Start/Draw Down Level - Negative Start</p> <p style="text-align: center;">Example: Absolute Level (Negative Start Level)</p> <table style="width:100%; border: none;"> <tr> <td style="width:50%;">System Setpoint (Example 150.0 PSI)</td> <td style="width:50%;">Feedback Scaling (P1-03) (Example 200.0 PSI)</td> </tr> <tr> <td>System Units (P1-02) (Example PSI P1-02=1)</td> <td>Start/Draw Down Level (P1-04) (Example -50.0 PSI, (150.0 - 50.0))</td> </tr> </table>	System Setpoint (Example 150.0 PSI)	Feedback Scaling (P1-03) (Example 200.0 PSI)	System Units (P1-02) (Example PSI P1-02=1)	Start/Draw Down Level (P1-04) (Example -50.0 PSI, (150.0 - 50.0))
0: No Unit	8: °F: DegFahrenheit																									
1: PSI: lb.SqrInch	9: °C: DegCelsius																									
2: Pa: Pascals	10: %: Percent																									
3: Bar	11: kPA: kilopascal																									
4: WC: Inch Water	25: Flow (Use P6-04)																									
5: "Hg: Inch Mercury	26: Custom Units																									
6: ft: Feet																										
7: m: meters																										
System Setpoint (Example 150.0 PSI)	Feedback Scaling (P1-03) (Example 200.0 PSI)																									
System Units (P1-02) (Example PSI P1-02=1)	Start/Draw Down Level (P1-04) (Example 100.0 PSI)																									
System Setpoint (Example 150.0 PSI)	Feedback Scaling (P1-03) (Example 200.0 PSI)																									
System Units (P1-02) (Example PSI P1-02=1)	Start/Draw Down Level (P1-04) (Example -50.0 PSI, (150.0 - 50.0))																									

8.4 Sleep Mode (Example)

WAIT FOR PRESSURE TO FALL BELOW START/DRAW DOWN LEVEL (P1-04)

8.5 Pump System Fault Setup

The drive will display a "Setpoint Not Met" fault when the drive is unable to maintain the programmed system setpoint due a problem with the pump system. Set P1-15 to the maximum allowed difference between setpoint and feedback level.

8.6 Low/High Feedback Level Detection

The drive continuously monitors the system feedback signal. Set the low feedback level parameter P1-08 to the minimum feedback level allowed for your system to display a "Low Feedback" fault. Set the high feedback level parameter P1-11 to the maximum feedback level allowed to display a "High Feedback" fault.

STEP 8

□ Fine-tune Settings for Pumping Application (continued)

8.7 Pre-Charge Operation

This function is used when the pump system requires a pre-charge before normal operation. Upon start, the drive will run at a fixed speed for a specified time or until the feedback signal reaches a programmed level and switches to auto mode operation.

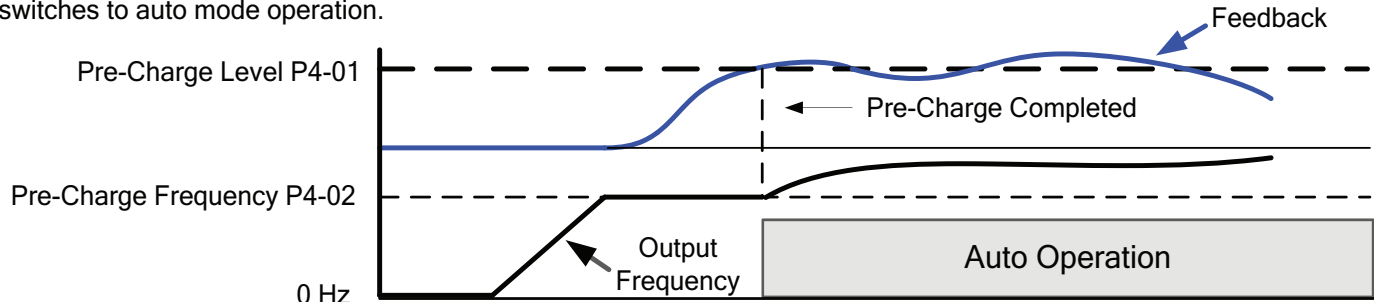

P4-01 Pre-Charge Level: Specified feedback level to stop pre-charge operation
 P4-02 Pre-Charge Frequency: Set desired pre-charge speed
 P4-03 Pre-Charge Time: Specified maximum pre-charge operation time

8.8 Thrust Bearing - Submersible Motors

The factory recommends using the Thrust Bearing function to prevent excess motor wear when using a submersible motor in combination with the drive. Enter the minimum motor frequency in parameter P4-11 to enable this function.

Example:

Minimum motor speed 1800 RPM
 $1800 \text{ RPM} \div 3600 \text{ RPM} \times 60.0 \text{ Hz} = 30.0 \text{ Hz}$

Thrust Acceleration Time P4-11
 (Example 1.0 seconds) Default setting

Thrust Bearing Frequency P4-12
 (Example 30.0 Hz) Default setting

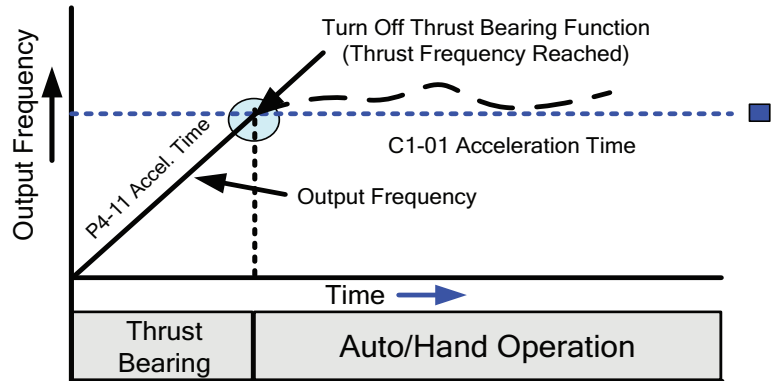

8.9 Auto Operation - Power Down Storage

Set parameter P4-10 = 1 to allow the drive to automatically start after power failure when operated from the HOA keypad. This function is recommended when operating the drive in remote or unmanned areas.



Warning! Sudden Movement Hazard. Ensure all personnel remain clear of the motor when P4-10 = 1. Failure to comply may result in death or serious injury due to sudden equipment movement.

STEP 9 **Verify Pump Rotation and Transducer Feedback**

9.1 Check the motor for proper direction and operation.

This test is performed solely from the HOA keypad. Apply power to the drive after making electrical connections and installing covers. The HOA keypad should display as shown in Figure 9.1. The motor should not be running until Step 9.2 is performed.

Figure 9.1 HOA Keypad Display

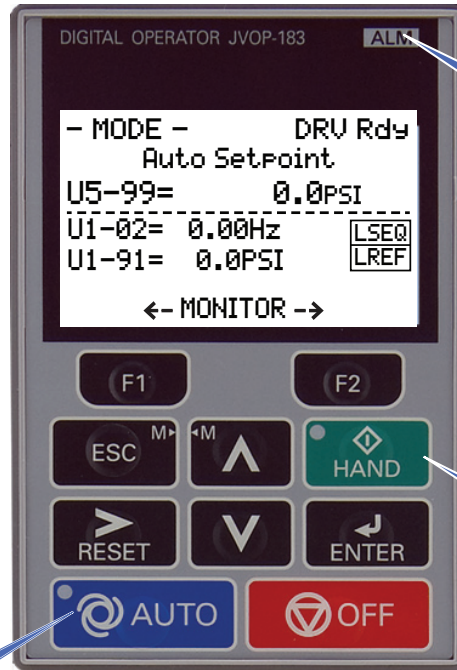

No alarm active

Hand Mode Off

Auto Mode Off

9.2 Motor Rotation Test (Standard)

Press the **F1** key to return to the main menu.

Press **HAND** on the HOA keypad. The display should read:

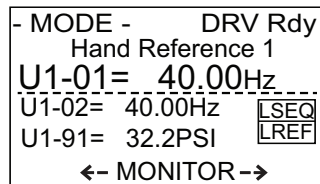

The **HAND** LED should be ON.

The motor should now be operating and in the correct direction of pump.

Press **OFF** on the HOA keypad. The display should read as in Figure 9.1.

Press **ENTER** to access Hand Speed. Use **M+**, **M-**, **RESET** to change

Hand Speed value. Press **ENTER** to save value

Note: If the direction of rotation is not correct, de-energize the drive and follow step 9.3.

STEP
9

Verify Pump Rotation and Transducer Feedback (continued)

9.3  **Exchange Output Leads**

De-energize the drive and wait at least five minutes until the charge indicator extinguishes completely before touching any wiring, circuit boards or components. Failure to comply may result in electrocution.

Exchange Output Leads



Swap any two of the three output leads to the motor (U/T1, V/T2 and W/T3) to change the motor rotation direction. Refer to Figure 3.1.

Repeat Step 9 to confirm the direction of motor rotation.

9.4 Feedback Signal Check

Verify Feedback on Display

Verify feedback on display matches the mechanical pressure gauge.

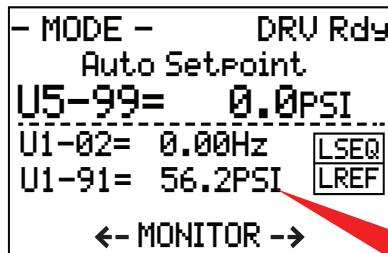

Refer to parameter P1-02 and P1-03, if the feedback device scaling or system units are incorrect.

STEP
10

AUTO Mode Operation

Perform these tasks to operate the drive in AUTO mode:

- Program all parameters
- Verify motor rotation direction
- AUTO Mode: Select the frequency reference source setting in parameter b1-01 (Refer to Step 4.6 for an example of setting a parameter.)
- b1-01 = 0 is the default setting (Operator/HOA Keypad)
- AUTO Mode: Select the run command source setting in parameter b1-02 (Refer to Step 4.6 for an example of setting a parameter.)
- b1-02 = 0 is the default setting (Operator/HOA Keypad)

STEP 10 **AUTO Mode Operation (continued)**

10.1 Place the Drive into AUTO Mode.

Press the AUTO key to place the drive into AUTO mode.

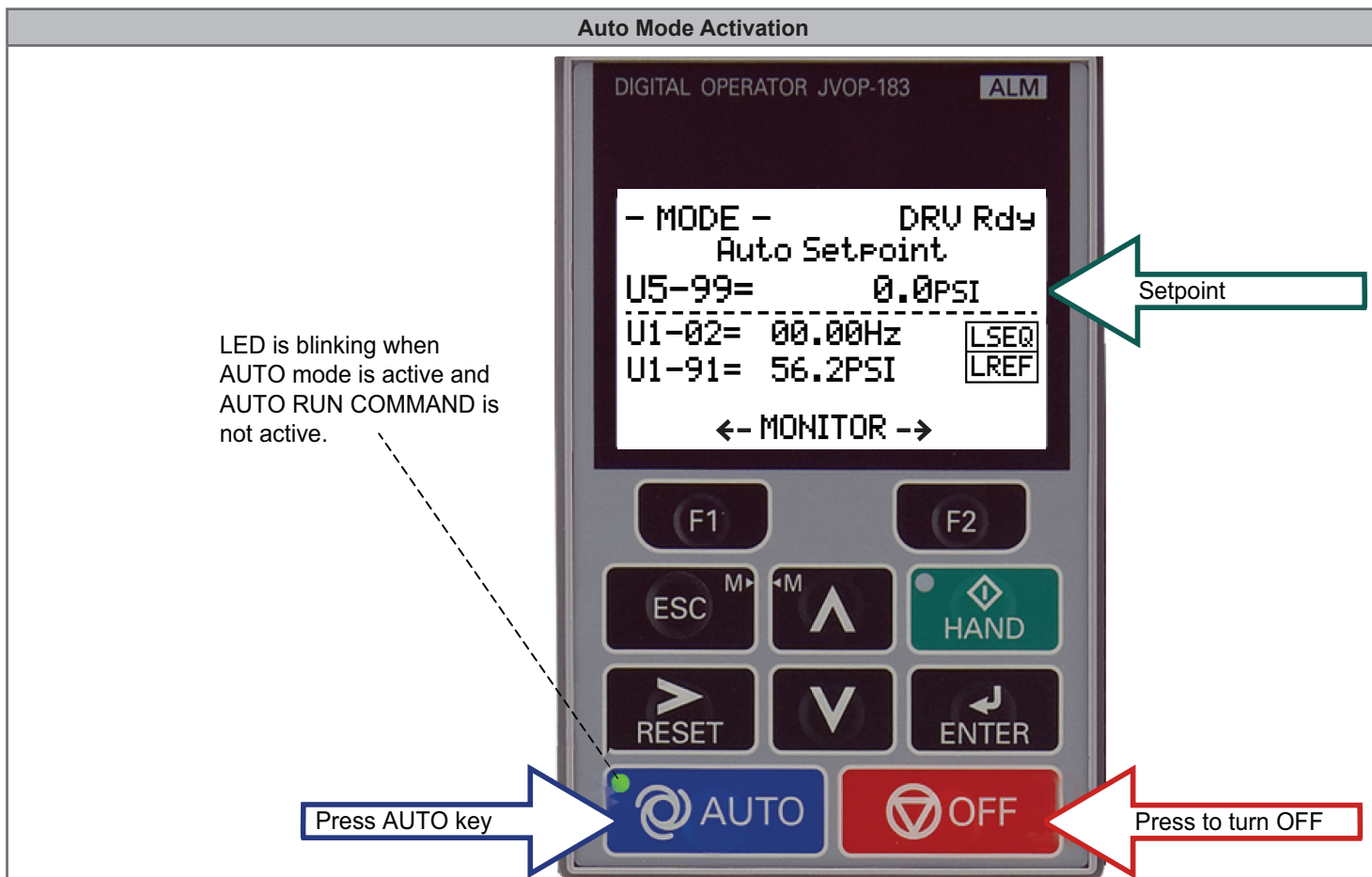

The drive is capable of starting or stopping based on the Run Command Selection setting in parameter b1-02. (Refer to Step 4.6 for an example of setting a parameter.)

The setpoint used in AUTO mode is based on the Frequency Reference Selection setting in parameter b1-01. (Refer to Step 4.6 for an example of setting a parameter.)

10.2 Set System Setpoint

Press  to access or modify the system setpoint in parameter Q1-01 within the Quick Setup Menu.

Press  to select the digit and    to change the system setpoint.

Press  to store setpoint and press  to return to the main operation menu.

STEP
10

□ AUTO Mode Operation (continued)

10.2 Set System Setpoint (continued)

10.2 Set System Setpoint

```

- MODE -      DRU Rdy
  Auto Setpoint
  U5-99= 0.0PSI
  U1-02= 0.00Hz  LSEQ
  U1-91= 56.2PSI  LREF
  <- MONITOR ->
    
```

Press AUTO key to start the drive.



The drive starts in AUTO mode when the feedback signal falls below the programmed level in parameter P1-04 for the time specified in P1-05.

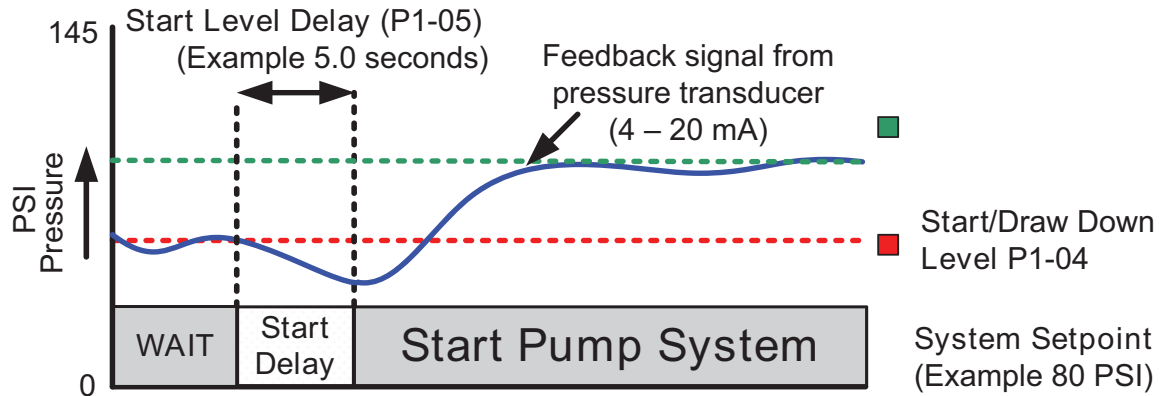

Refer to Figure 8.2, Start/Draw Down Level.

STEP 11 **Hand Mode Operation**

11.1 HAND Mode

Perform these tasks to operate the drive in HAND mode:

- Program all parameters
- Verify motor rotation direction

HOA Keypad

DIGITAL OPERATOR JVOP-183 ALM

- MODE - DRV Rdy
Hand Reference 1

U1-01= 40.00Hz
U1-02= 40.00Hz LSEQ
U1-91= 34.2PSI LREF

←- MONITOR ->

-MONITR- PRG
Hand Reference 1

P5-02= 0040.0Hz
(0.0~60.0)
"40.0Hz"

HOME FWD ->

Press to access HAND Speed. Use to change HAND Speed value.

Press to save value.

Adjust Hand Speed from Analog Input (0 – 10 V)

Set parameter P5-01 (HAND Mode Ref.) to 0 to adjust the hand mode reference from an external 0 – 10 V signal connected to terminals AC and A3.

0 – 10 V Connection

0 ~ 10 Vdc

STEP
12

Programming Advanced Parameters

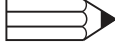
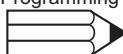
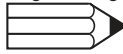
Task	Parameter	Name	Description/Menu Access	Default Value
12.1 NOTICE: Adjusting this parameter may cause PID control loop instability if misadjusted.	b5-03	Integral Time Setting (I)	Sets the integral time for the PID controller. Decrease integral time to make the drive more responsive. Programming 	3.0 seconds
12.2 NOTE: Disable parameter b5-12 if a transducer is not installed.	b5-12	Feedback Loss 4 to 20 mA Detection Selection	Performs a 4 to 20 mA wire break detection on the analog input that is programmed for PID feedback. Terminal TB1-1 A2 (typical) 0: Disabled, continue running, no message is displayed. 1: Alarm, display warning on the HOA keypad when the feedback device fails or is disconnected. 2: Fault, stop the pump system when the feedback fails or is disconnected. 3: Run at the setting value of parameter b5-13.	2 (Fault)
12.3 Adjust depending on system performance.	C1-01	Acceleration Time 1	Sets the time to accelerate the pump motor from zero to maximum speed. Programming  NOTE: The factory default with Thrust Mode enabled is 12.0 seconds, 20.0 seconds when disabled.	20.0 seconds See Note
	C1-02	Deceleration Time 1	Sets the time to decelerate the pump motor from maximum speed to zero. Programming  Note: The factory default with Thrust Mode enabled is 5.0 seconds, 10.0 seconds when disabled.	10.0 seconds See Note
12.5 Refer to L5 parameter group (See U1000 iQpump Drive User Manual No. TOEPYAIUPW01). The number of restart attempts is set by L5-01. Configurable drive System Protection Faults for Auto-restart: - Low Level Feedback - High Level Feedback - Transducer Loss - Not Maintaining Setpoint - Loss of Prime - Pump Over Cycle.	L5-01	Number of Restart Attempts	Sets the number of times the drive may attempt to restart after these faults occur: <ul style="list-style-type: none"> - Aov - Power Supply Overvoltage - GF - Ground Fault - LF - Output Phase Loss - LSo - LSo Fault - oC - Overcurrent - oH1 - Drive Overheat - oL1 - Motor Overload - oL3 - Overtorque 1 - oL4 - Overtorque 2 - ov - DC Bus Overvoltage - STo - Pull-Out Detection 	5

STEP
12

Programming Advanced Parameters (continued)

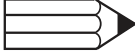
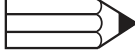
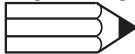
Task	Parameter	Name	Description/Menu Access	Default Value
<p>12.6 P1-06 should be set to the level at which the pump produces minimum pressure even at zero flow. Example: Base pump motor speed is 3600 RPM, minimum speed is 2400 RPM. Set minimum pump frequency to 40.0 Hz. ($2400 \div 3600 \times 60 \text{ Hz} = 40 \text{ Hz}$)</p>	P1-06	Minimum Pump Speed	<p>Minimum frequency at which the drive will run. Applies to both HAND and AUTO modes.</p> <p>NOTE: For minimum pump frequency, the drive will use the highest setting from among P1-06, P4-12 (Thrust Bearing Frequency), or d2-02 (Reference Lower Limit).</p>	40.0 Hz
<p>12.7 Adjust this parameter according to system requirements.</p>	P2-03	Sleep Delay Time	<p>Sets the delay time before the drive enters Sleep Mode when the selected signal level (P2-01) falls below the specified sleep level (P2-02).</p> <p>Programming </p>	5 seconds
<p>12.8 Primarily used for submersible pumps. Program P4-12 = 0.0 Hz to disable function when the drive is used with a centrifugal pump.</p>	P4-12	Thrust Bearing Frequency	<p>Sets the frequency reference used when the thrust bearing function is active. The drive will accelerate to this frequency in the time set to P4-11. The drive will decelerate from the frequency in the time set to P4-13.</p> <p>Programming </p>	30.0 Hz
<p>12.9 Set the amount of time for the drive to delay starting if a Run command is present at power-up.</p> <p>Note: Utility Start Delay is active when P4-10 is enabled and operation (start/stop) is from the HOA keypad.</p>	P4-17	Utility Start Delay	<p>Sets the amount of time that the drive will delay starting if a Run command is present at power-up. The drive waits the time specified in P4-11 before auto operation becomes active when utility power is restored and P4-10 is enabled.</p> <p>Programming </p>	<p>0.2 minutes</p> <p>Setting this parameter to 0.0 disables the function.</p>

STEP
13

□ Sleep and Anti-No-Flow (ANF) Detection (P2-23, P2-24, P2-25)

Note: Before adjusting Anti-No-Flow operation, ensure the system is regulating satisfactory while operating under normal running conditions.

If the system is stable, continue to Step 13.1 to verify no-flow/sleep operation. If the system is unstable, turn off the Anti-No-Flow function (P2-23 = 0.00 %) and adjust the PI control parameters, b5-02 and b5-03 to stabilize the pump system. Refer to the U1000 iQpump Drive User Manual (Document No. TOEPYAIUPW01) for additional information. After the system is stabilized, re-enable the Anti-No-Flow function by setting P2-23 to 0.40 % and continue to Step 13.1 to verify no-flow/sleep operation.

13.1 Verify system holds pressure by creating a no-flow situation (e.g. close off discharge valve).

13.2 Press OFF button on the HOA keypad, wait 1 minute until system stabilizes and verify system pressure feedback U1-91. If the pressure drops more than 3 PSI (U1-91) adjust P2-25 to the actual delta pressure drop plus 1 PSI.

Example: Setpoint is 80 PSI. Pressure feedback U1-91 displays 76 PSI. P2-25 should be 4 + 1 or 5 PSI.

Note: The pump system will continue to cycle on and off if this value is not greater than the start level (P1-04). The system pressure is not holding and needs correction if this occurs.

13.3 Run system in normal automatic operation with flow. Check monitor U1-99 “ANF Timer” and verify that the value is incrementing and resetting back to zero continuously. If the value holds at 10 seconds (P2-24), increase P2-24 “Anti-No-Flow Detection Time” by increments of 5 seconds. Repeat Step 13.3 each time P2-24 is adjusted.

13.4 Create a no-flow situation, (e.g. close discharge valve), and monitor that U1-99 “ANF Timer” increments and holds at P2-24 time (value set in Step 13.3). Once the Anti-No-Flow timer expires, the speed will reduce gradually until it reaches minimum pump speed (P1-06) where it will hold for 5 seconds (P2-03) before going to sleep.

13.5 Run the system in normal automatic operation and verify sleep and wake-up operation until the system performs satisfactory.

NOTES:

Low Harmonic Regenerative Pump Controller U1000 iQpump Drive Quick Start Procedure

YASKAWA AMERICA, INC.

2121, Norman Drive South, Waukegan, IL 60085, U.S.A.
Phone: 1-800-YASKAWA (927-5292) or 1-847-887-7000 Fax: 1-847-887-7310
<http://www.yaskawa.com>

DRIVE CENTER (INVERTER PLANT)

2-13-1, Nishimiyaichi, Yukuhashi, Fukuoka, 824-8511, Japan
Phone: 81-930-25-3844 Fax: 81-930-25-4369
<http://www.yaskawa.co.jp>

YASKAWA ELECTRIC CORPORATION

New Pier Takeshiba South Tower, 1-16-1, Kaigan, Minatoku, Tokyo, 105-6891, Japan
Phone: 81-3-5402-4502 Fax: 81-3-5402-4580
<http://www.yaskawa.co.jp>

YASKAWA ELÉTRICO DO BRASIL LTDA.

777, Avenida Piraprinha, Diadema, São Paulo, 09950-000, Brasil
Phone: 55-11-3585-1100 Fax: 55-11-3585-1187
<http://www.yaskawa.com.br>

YASKAWA EUROPE GmbH

185, Hauptstraße, Eschborn, 65760, Germany
Phone: 49-6196-569-300 Fax: 49-6196-569-398
<http://www.yaskawa.eu.com>

YASKAWA ELECTRIC KOREA CORPORATION

9F, Kyobo Securities Bldg., 26-4, Yeouido-dong, Yeongdeungpo-gu, Seoul, 150-737, Korea
Phone: 82-2-784-7844 Fax: 82-2-784-8495
<http://www.yaskawa.co.kr>

YASKAWA ELECTRIC (SINGAPORE) PTE. LTD.

151, Lorong Chuan, #04-02A, New Tech Park, 556741, Singapore
Phone: 65-6282-3003 Fax: 65-6289-3003
<http://www.yaskawa.com.sg>

YASKAWA ELECTRIC (THAILAND) CO., LTD.

252/125-126, 27th Floor, Muang Thai-Phatra Tower B, Rachadapisek Road, Huaykwang, Bangkok, 10310, Thailand
Phone: 66-2693-2200 Fax: 66-2693-4200
<http://www.yaskawa.co.th>

YASKAWA ELECTRIC (CHINA) CO., LTD.

22F, One Corporate Avenue, No.222, Hubin Road, Shanghai, 200021, China
Phone: 86-21-5385-2200 Fax: 86-21-5385-3299
<http://www.yaskawa.com.cn>

YASKAWA ELECTRIC (CHINA) CO., LTD. BEIJING OFFICE

Room 1011, Tower W3 Oriental Plaza, No. 1, East Chang An Ave.,
Dong Cheng District, Beijing, 100738, China
Phone: 86-10-8518-4086 Fax: 86-10-8518-4082

YASKAWA ELECTRIC TAIWAN CORPORATION

9F, 16, Nanking E. Rd., Sec. 3, Taipei, 104, Taiwan
Phone: 886-2-2502-5003 Fax: 886-2-2505-1280

YASKAWA INDIA PRIVATE LIMITED

#17/A, Electronics City, Hosur Road, Bangalore, 560 100 (Karnataka), India
Phone: 91-80-4244-1900 Fax: 91-80-4244-1901
<http://www.yaskawaindia.in>

YASKAWA

YASKAWA AMERICA, INC.



TOEPYAIUPW02

In the event that the end user of this product is to be the military and said product is to be employed in any weapons systems or the manufacture thereof, the export will fall under the relevant regulations as stipulated in the Foreign Exchange and Foreign Trade Regulations. Therefore, be sure to follow all procedures and submit all relevant documentation according to any and all rules, regulations and laws that may apply.

Specifications are subject to change without notice for ongoing product modifications and improvements.

© 2017 YASKAWA AMERICA, INC.

MANUAL NO. TOEPYAIUPW02B

Published in USA February 2018 <1>